

Braemar evaporative air conditioning

The perfect degree of comfort and energy efficiency



**AUSTRALIAN
DESIGNED, MADE
AND OWNED**

“Seeley International never stops striving to innovate and build the world’s most energy efficient heaters and air conditioners.

It is this commitment to excellence that’s at the heart of everything we do.”

Frank Seeley AM, DUniv Flin, FAICD
Founder and Executive Chairman



NEW!

**Introducing the
Black Magic™
MINI-CELL^
CHILLCEL® Pads**

Our revolutionary **Black Magic™ Mini-Cell^ Chillcel® pads** have transformed the aesthetics of our coolers as they seamlessly blend into their surroundings; maintaining our global leading Mini-cell^ Chillcel® pad technology, which increases surface area of the pads by 25%, dramatically multiplying cooling capacity and efficiency - **BEYOND BELIEF!**

^Patent pending.

The award winning company

Seeley International consistently wins awards each year for new product design, innovation and the environment. Recent awards include:



Absolute excellence in energy efficiency and comfort



COST EFFECTIVE

Up to 80% cheaper to run*
Save up to 80% on energy bills when compared to a reverse cycle air conditioner



AUSTRALIAN MADE AND OWNED

Manufactured by family owned Seeley International, Australia's largest air conditioning manufacturer



WARRANTY

Quality that lasts – 7 year comprehensive warranty**
65 year history of Braemar excellence and reliability



QUALITY

NATA accredited test results substantiate superior product performance
Simple to install, maintain and operate



LIFESTYLE

Perfect for alfresco living, with options for security vents so you can leave doors and windows closed
Whisper quiet operation



ENVIRONMENT

Delivers fresh, outside air – not stale recycled air
Up to 80% less nasty CO₂ emissions#

*Refer to page 4. **The 7 year comprehensive warranty is available exclusively (i.e. only) from Seeley International participating dealers. The warranty has terms and conditions, including the requirement for servicing of the product in accordance with the owner's manual. In the fourth year the service must be performed by Seeley International or its appointed nominee. #Refer to page 5.

Up to 80% cheaper to run

With **Braemar inverter models – Evolution and SuperStealth®**, you can save up to 80% on your energy bills when compared to a ducted reverse cycle air conditioner, that's a **saving of up to \$250 per year!**

Running costs per year*

Compared to a ducted reverse cycle system

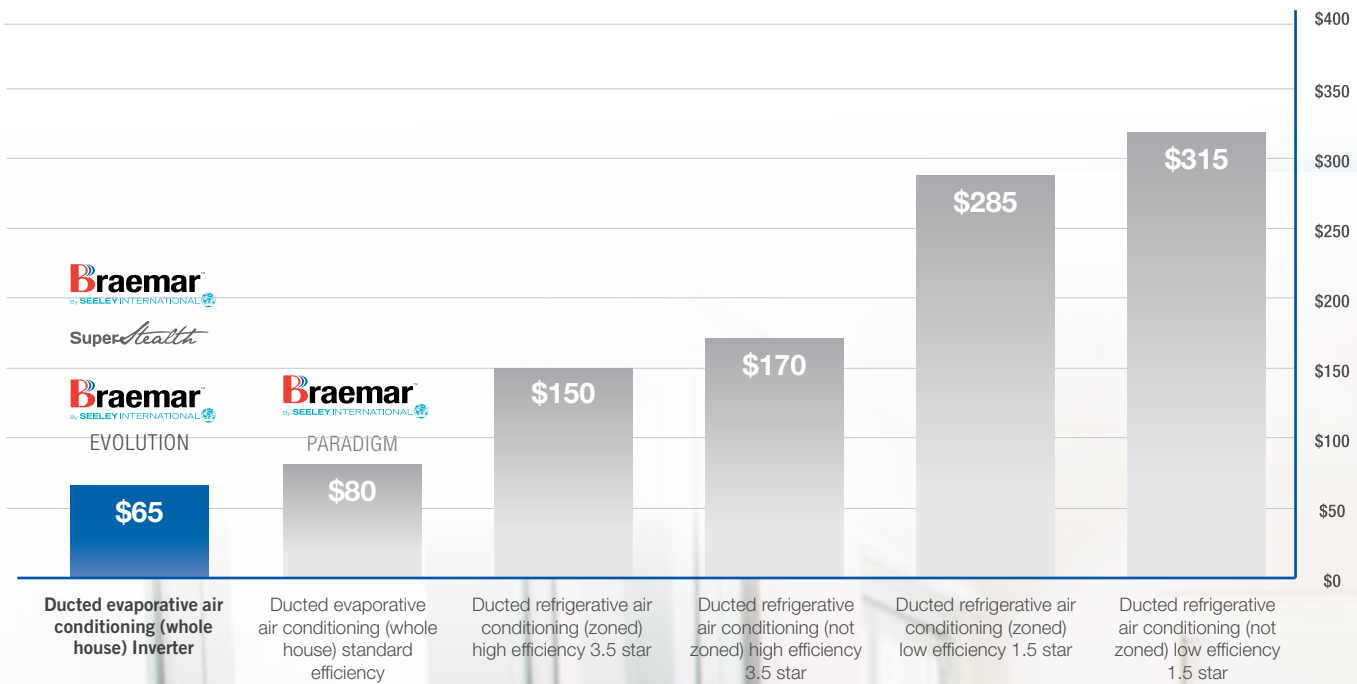

*Seeley International's calculation based on approximate running costs figures from publically sourced data. Comparison with 2 star not zoned ducted refrigerative system in a large size (220m²) 2-star pre 2005 house in a Melbourne climate, cooling all day on the weekend and in the morning and evenings when internal temperatures are high, and an electricity tariff of 31.9c/kWh. Water cost excluded.

Minimal water usage



Braemar evaporative air conditioning uses up to 83% less water over summer than a shower*



Responsible use of renewable resources

Reduce your carbon footprint

With **Braemar inverter models – Evolution and SuperStealth®**, you'll reduce your impact on the environment by producing up to **80% less CO₂ emissions** when compared to a ducted reverse cycle air conditioner.^

CO₂ Emissions (kg/Yr)^

Compared to a ducted reverse cycle system

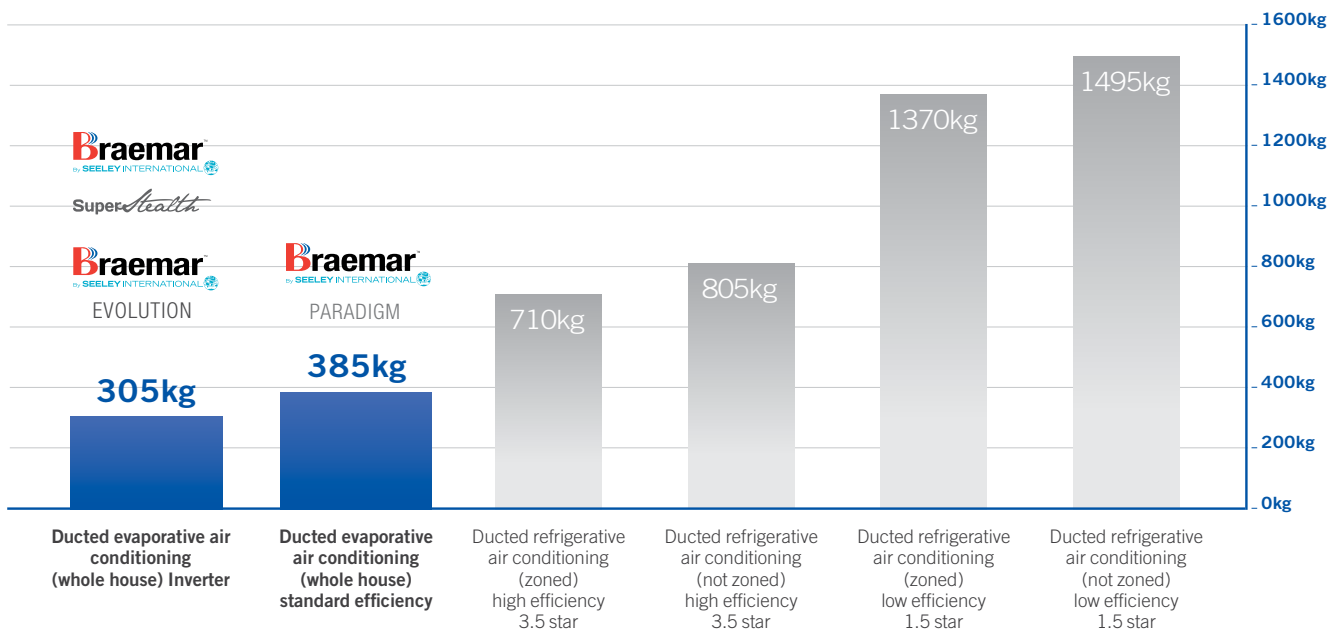

*Water use calculations for shower are based on shower water use for 4 people, 10 mins per person per day at 9L/min, over three months, calculated at 32,400 L. Water use calculations for Braemar evaporative air conditioning over three months are 5,405 L.

^Seeley International's calculation based on approximate running costs figures from publically sourced data. Comparison with 2 star not zoned ducted refrigerative system in a large size (220m²) 2-star pre 2005 house in a Melbourne climate, cooling all day on the weekend and in the morning and evenings when internal temperatures are high.

MAGIQTOUCH[®] Controller

Touch screen technology

Smart, sophisticated and incredibly intuitive, your MagIQtouch[®] controller makes operating your Braemar so simple. Discreet and modern design will blend seamlessly into the decor of your home. Choose between standard, Wi-Fi enabled or wireless Radio Frequency MagIQtouch[®] controller options.

MAGIQTOUCH[®] controller



Can be Wi-Fi enabled for use with our smart app and smart home integration[^]

MAGIQTOUCH[®] Radio Frequency controller



Use the latest in Radio Frequency (RF) channel hopping technology with no need for wiring

Main Features



Program Mode

Programmable 7 day, 4 time period program, customisable to suit your lifestyle (including a temporary over-ride function).



Useful Settings

Access features such as child lock, quiet mode and servicing information.



Optional Extra MAGIQTOUCH[®] AIR SENSOR

MagIQtouch[®] Air Sensor monitors temperature and humidity levels. It allows you to mount your MagIQtouch[®] controller in the most convenient place in your home, as the MagIQtouch[®] Air Sensor will then take over temperature control from the MagIQtouch[®] controller. This can then be located in the best place in the house to ensure ultimate cooling comfort for everyone.



MAGI@TOUCH®

Wi-Fi SMART APP*



Control your cooling comfort needs directly from your mobile device! For example, turn on your cooler wherever you are, ensuring you come home to a cool home on those hot summer days.

The smart app is free and available for download on your smartphone.



Available for download now on iOS and Android



SMART HOME INTEGRATION*



Control temperature and fan speeds with your voice through Amazon® Alexa and your Google Assistant^ technologies.

Voice commands are easy and simple to use, like "Alexa, turn on my Cooler" or "Hey Google, set the Cooler to 21 degrees".



Google Home



amazon echo



*Requires MagiQtouch® wall control, MagiQtouch® Wi-Fi smart kit and MagiQtouch® account to operate.

^Requires Wi-Fi, Google Account and a compatible device. Google and Google Home are trademarks of Google LLC.

^Requires Wi-Fi, Amazon Account and a compatible device.

Braemar ducted evaporative air conditioning

Features and benefits

— Para

Exceptional water distribution increases cooling effect

- This Australian designed, world patented, free flow, water distributor ensures constant, even pad saturation increasing the cooling effect and outperforming competitor products

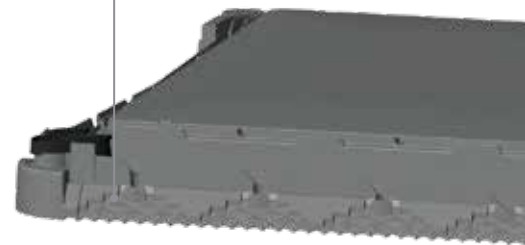

Breakthrough Black Magic™ MINI-CELL^ CHILLCEL® pad technology

- The only evaporative cooling medium of its kind. Fully manufactured in Australia to address the harsh Australian climate. It's an **absolute out-performer!**
- Exclusive small cell design provides cutting-edge cooling capacity.
- Maintains our global leading Mini-cell^ Chillcel® pad technology, which increases surface area of the pads by 25%, dramatically multiplying cooling capacity and efficiency - **BEYOND BELIEF!**
- **Black Magic™ MINI-CELL^ CHILLCEL® pads** deliver transformational aesthetics to your home enabling the unit to blend seamlessly into its surroundings.

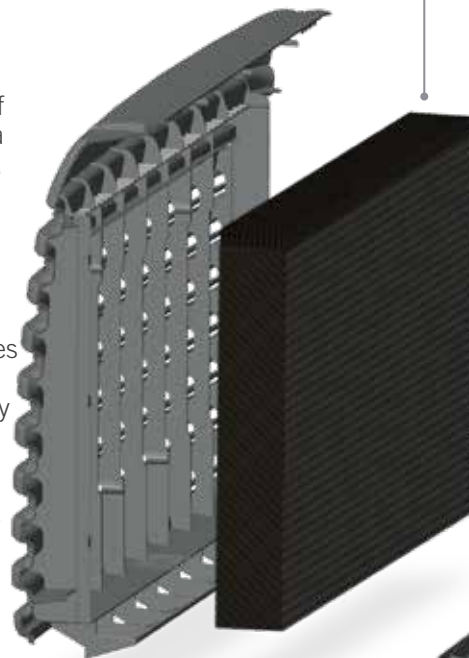

^Patent pending

Tornado® pump that won't block

- Australian designed and manufactured
- Exceptional reliability in extreme conditions
- Dual directional – it can't block!



AutoWinterseal™ reduces draughts and dust

- Automatic sealing system
- Reduces need for winter cover

Auto water draining keeps your system clean

- Empties the reservoir automatically when system is not in use, leaving it clean and dry
- Ensures the system is operating at maximum efficiency, while using the minimum amount of water
- Helps to avoid the seasonal maintenance* as required by some other similar products

*Seasonal maintenance does not replace regular maintenance of the unit as required for peak performance.

Conditioning

Paradigm



Highly durable and non-corrosive cabinet and water reservoir

- High performance Permatuf® polymer construction will not corrode or rust

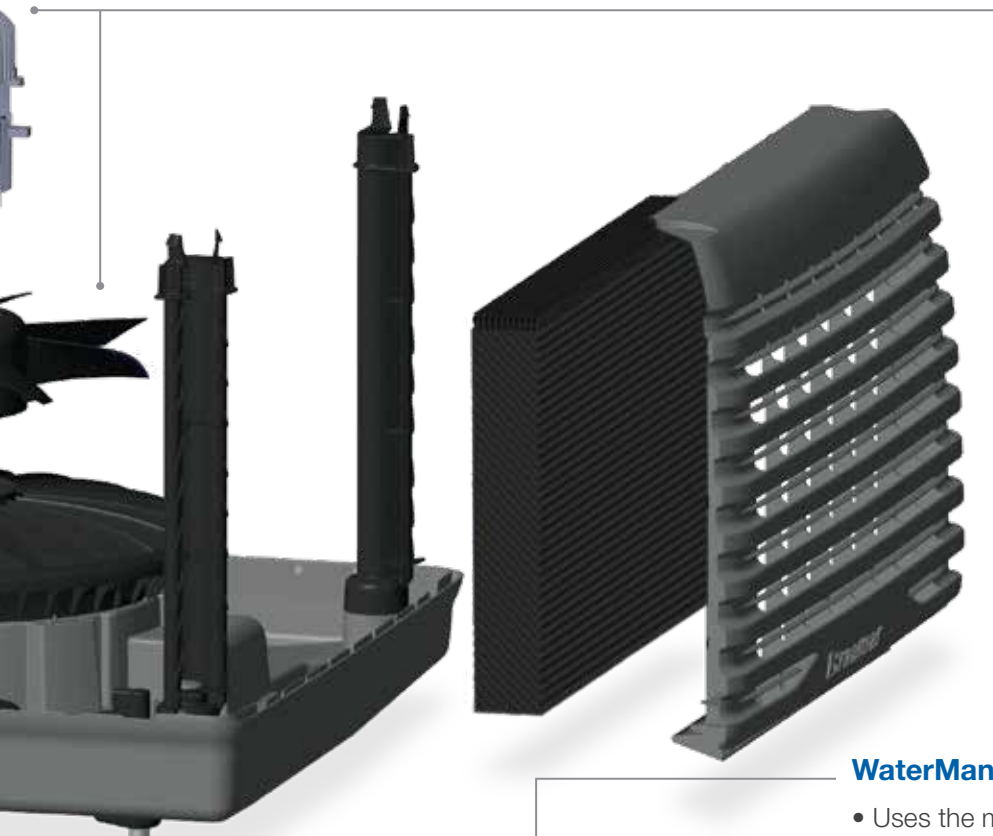

Stealth® fan is whisper quiet (Paradigm)

- Advanced aerodynamic design
- Super quiet in operation
- Produces a constant, cool, quiet, refreshing breeze

Totally enclosed tropic proof motor (Paradigm)

- Ensures long term performance and incredible reliability of your system
- Variable speed motor offers maximum control over your family's comfort level all summer through



WaterManager™ saves water

- Uses the minimum amount of water to achieve high efficiency cooling
- Water quality monitoring to maximise water savings
- Keeps your system clean

Firewall ember screen (optional extra)

- Helps guard against ember attack in bushfires
- Made from non-combustible mesh
- Maximum aperture of 2mm
- Can be fitted to existing cooler pad frames
- Minimal reduction in air flow of 5%
- To meet the BAL rating, the cooler also requires a firewall auto seal installed
- Fitting both ember screen and auto seal to comply with BAL will reduce airflow by up to 15%

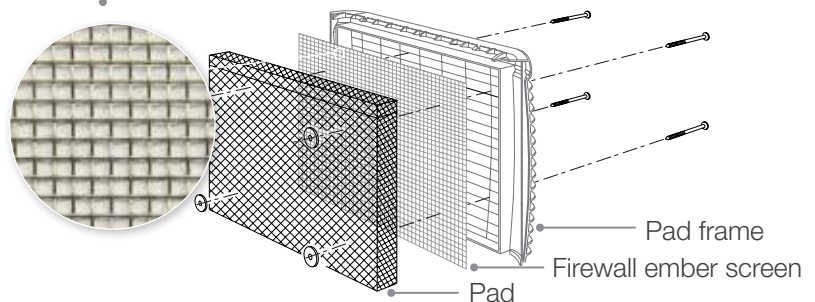

Braemar ducted evaporative air conditioning range

Evolution

The Braemar Evolution is the highest capacity sloped tank evaporative air conditioner on the market*...and one of the smallest. With its low profile, sleek design, it unobtrusively sits below the roof ridgeline to blend seamlessly into your home.



Model	Cooling capacity (kW)	Nominal power motor (W)	Length (mm)	Width (mm)	Height – Front (mm)	Height – Rear (mm)	Operating weight (kg)	Airflow (L/s)
Evolution LPQI250	8.4	340	1150	1150	730	380	86	1510
Evolution LPQI350	10.4	430	1150	1150	730	380	86	2010
Evolution LPQI450	11.8	600	1150	1150	730	380	86	2390
Evolution LPQI550	13.2	950	1150	1150	730	380	86	2850

The above data was drawn from Meridian Test Laboratory's test analysis. The testing was performed by a NATA accredited laboratory to the requirements of the Australian standard AS2913-2000 "Evaporative Air Conditioning Equipment." Achievable with ambient 38 °C DB, 21°C WB, room temperature 27.4 °C.

Available colours*

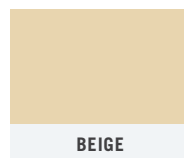

* Colours may vary. Heritage Green made to order.

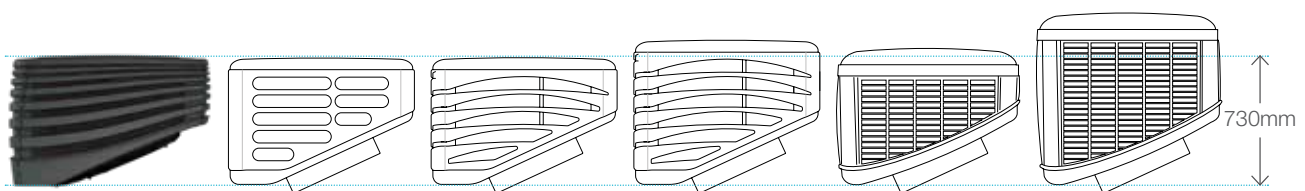

Braemar
by SEELEY INTERNATIONAL
evolution series

other brand

other brand

other brand

other brand

other brand



SuperStealth®

Invertair™ Series

The world's first high performance inverter axial evaporative cooler with the highest cooling capacity and energy efficiency.

- Ultra-quiet cooling
- Outstanding cooling performance
- Option to upgrade to MagiQtouch® controller.



Model	Cooling capacity (kW)	Nominal power motor (W)	Length (mm)	Width (mm)	Height (mm)	Operating weight (kg)	Airflow (L/s)
SuperStealth LCQI250	8.1	340	1150	1150	685	88	1500
SuperStealth LCQI350	9.9	430	1150	1150	685	88	1990
SuperStealth LCQI450	13.5	600	1150	1150	835	91	2620
SuperStealth LCQI550	14.3	950	1150	1150	835	91	3070

Available colours*



*Colours may vary.

Evolution and SuperStealth®

SuperStealth® fan is ultra-quiet

- Specifically designed to be more energy efficient
- Quieter than the standard Stealth Fan

SuperStealth® inverter motor

- Highly efficient throughout the operating range
- Uses far less energy than a standard fan and motor



Paradigm Series

Proven performer

- Braemar quality and reliability
- High efficiency
- Option to upgrade to MagIQtouch® controller.



Model	Cooling capacity (kW)	Nominal power motor (W)	Length (mm)	Width (mm)	Height (mm)	Operating weight (kg)	Airflow (L/s)
Paradigm LCQ250	7.6	340	1150	1150	685	79	1520
Paradigm LCQ350	10.2	430	1150	1150	685	80	1980
Paradigm LCQ450	13.2	600	1150	1150	835	89	2560
Paradigm LCQ550	14.1	950	1150	1150	835	91	2810

Available colours*



*Colours may vary. Heritage Green made to order.



Looking for a combined cooling and heating solution?

Seeley International's range of products also includes ducted gas heating that complements your evaporative air conditioning system. Take advantage of controlling your cooling and heating systems from the same controller – the innovative touch screen MagIQtouch® controller.

Ask your dealer for the right solution for your home.

Keep your home secure

Did you know you can cool your home without leaving your doors and windows open?

Ask your dealer about installing a cost effective and easy to install **Security Relief Vent** in your home, allowing you to run your evaporative air conditioner while you are out, with all your windows and doors safely closed and locked.

Your home will stay cooler as cooled air is released into the roof space. When you return home, simply open up your windows and doors as normal, maintaining the fresh cool air throughout your home and open living areas.



Comprehensive warranty

For complete peace of mind, Braemar backs every one of its air conditioning systems with an industry leading comprehensive warranty program.

This includes a 7 year warranty* (with a compulsory chargeable service in the fourth year), 10 year cover on all structural components, plus a hefty 25 year cover against corrosion, on its Permatuf® cabinets.

Please refer to your home owner's manual for all service and warranty terms and conditions.



Register your warranty and go into the draw to win \$500 worth of prizes[^]

Prize includes 2 free services (up to the value of \$400) and a \$100 eftpos gift card

All you need is your home owners' manual.

Visit seeleyinternational.com/warranty and follow the prompts.

Have your serial number ready.

[^]Terms and conditions apply. See braemar.com.au for more information, including the dates of the promotion



Braemar national service network

Seeley International has an established network of highly professional dealers and service agents throughout Australia. To book a service visit seeleyinternational.com/service or call 1300 650 444.

*The 7 year comprehensive warranty is available exclusively (i.e. only) from Seeley International participating dealers. The warranty has terms and conditions, including the requirement for servicing of the product in accordance with the owner's manual. In the fourth year the service must be performed by Seeley International or its appointed nominee.



BREEZAIR

Ducted Evaporative Air Conditioning

BRAEMAR

Ducted Evaporative Air Conditioning | Ducted Gas Heating
Reverse Cycle Air Conditioning | Gas Wall Furnaces and Space Heaters

CLIMATE WIZARD

Indirect Evaporative Air Conditioning

CONVAIR

Portable Air Conditioning

COOLAIR

Ducted Evaporative Air Conditioning

COOLERADO

Indirect Evaporative Air Conditioning

AIRA

Direct and Indirect Evaporative Air Conditioning | Ducted Gas Heating
Commercial Gas Space Heating | Energy Recovery Systems

INTEGRATED COMFORT INCORPORATED (ICI)

Dual Cool® Patented Dual Evaporative pre-cooling products

seeleyinternational.com/braemar

1300 360 815



With the generous support of our Australasian dealers we are proud to be the National Variety Bash partner supporting kids in need across Australia.

Seeley International Pty Ltd
ABN 23 054 687 035

112 O'Sullivan Beach Road, Lonsdale, SA 5160

Phone: (08) 8328 3850 Fax: (08) 8328 3950

Email: enquiries@seeleyinternational.com
seeleyinternational.com

Information in this brochure was correct at the time of preparation. E & OE

Cat No M378 REV G (0819) DEALER



Quality
ISO 9001